

SERIES

8069

シールドロック H=3.0mm

SHIELD LOCK

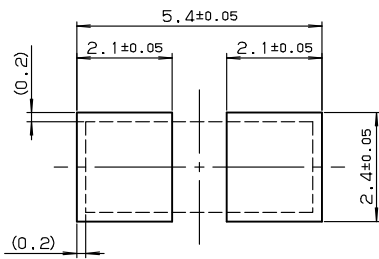

推奨パターンレイアウト
RECOMMENDED PATTERN LAYOUT

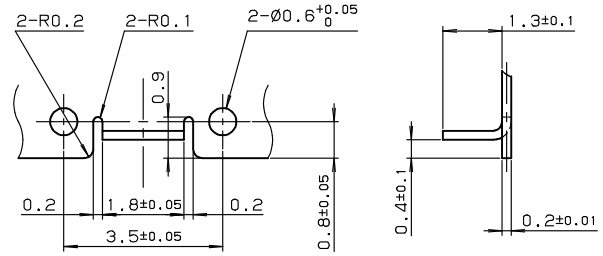

シールドケース形状
SHIELDING CASE FORM

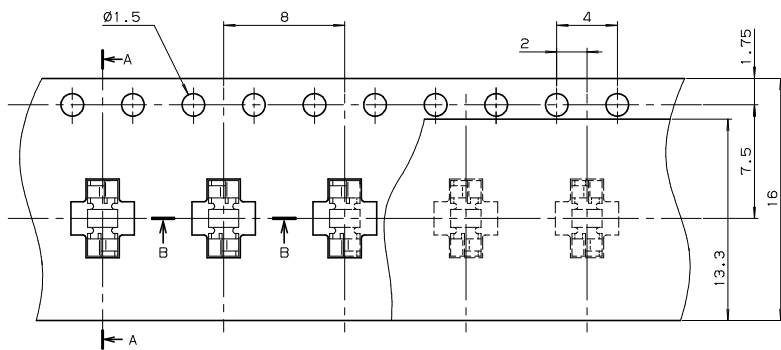
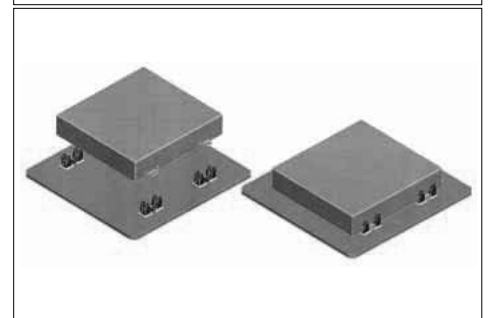
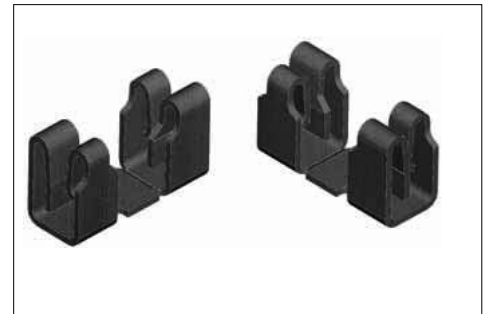
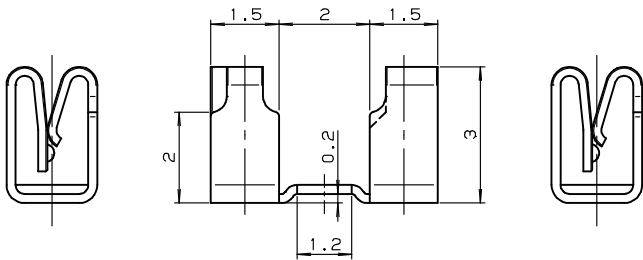
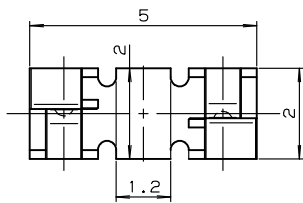

引出し方向

USED DIRECTION OF FEED

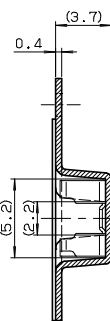

SECT. A-A

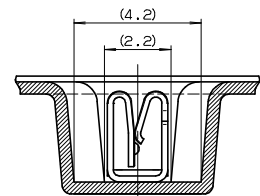

SECT. B-B

注文コード / Ordering Code

Part No. 04 8069 000 000 800 +



SERIES

8069

シールドロック H=1.8mm

SHIELD LOCK

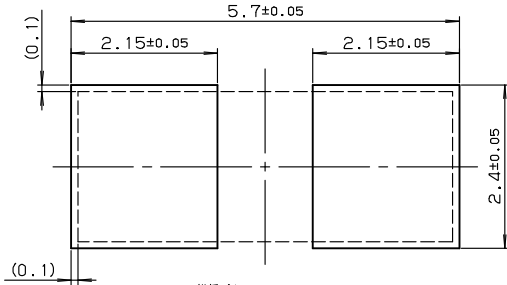

推奨パターンレイアウト
RECOMMENDED PATTERN LAYOUT

シールドロック斜視図
SHIELD LOCK

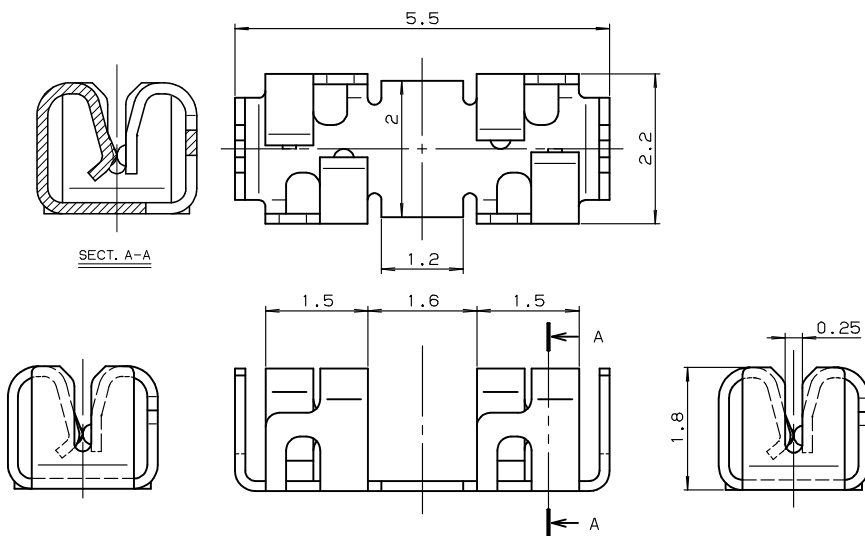
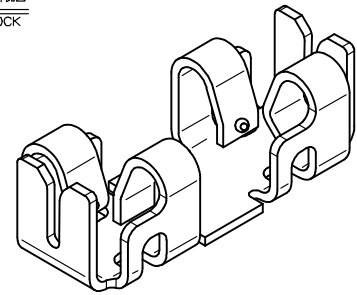

シールドロック嵌合状態斜視図
SHIELD LOCK MATING

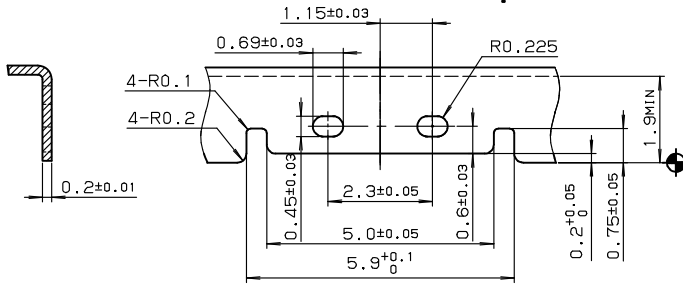
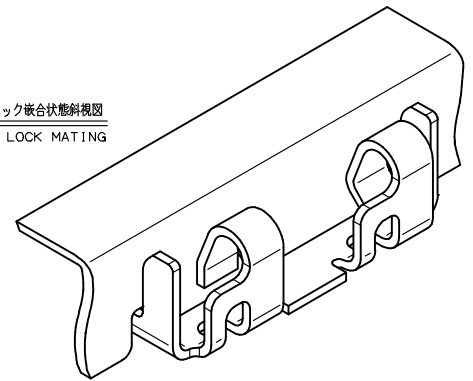

シールドケース形状
SHIELDING CASE FORM

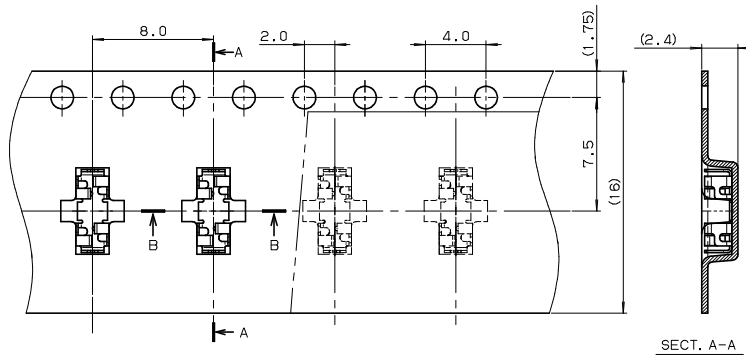

SECT. A-A

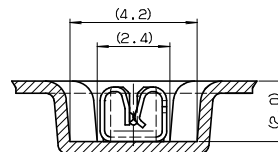

SECT. B-B

注文コード / Ordering Code

Part No. 04 8069 000 100 800 +



KYOCERA Connector Products Corporation