

ENERGIZER L92
Ultimate Lithium



Specifications

AAA

Classification:	"Cylindrical Lithium"
Chemical System:	Lithium/Iron Disulfide (Li/FeS ₂)
Designation:	ANSI 24-LF, IEC-FR03
Nominal Voltage:	1.5 Volts
Storage Temp:	-40°C to 60°C (-40°F to 140°F)
Operating Temp:	-40°C to 60°C (-40°F to 140°F)
Typical Weight:	7.6 grams (0.3 oz.)
Typical Volume:	3.8 cubic centimeters (0.2 cubic inch)
Max Discharge:	1.5 Amps Continuous
(single battery only)	2.0 Amps Pulse (2 sec on / 8 sec off)
Max Rev Current:	2 uA
Typical Li Content:	Less than 1 gram
Typical IR:	140 to 180 milliohms (depending on method)
Shelf Life:	15 years at 21°C

Industry Standard Dimensions

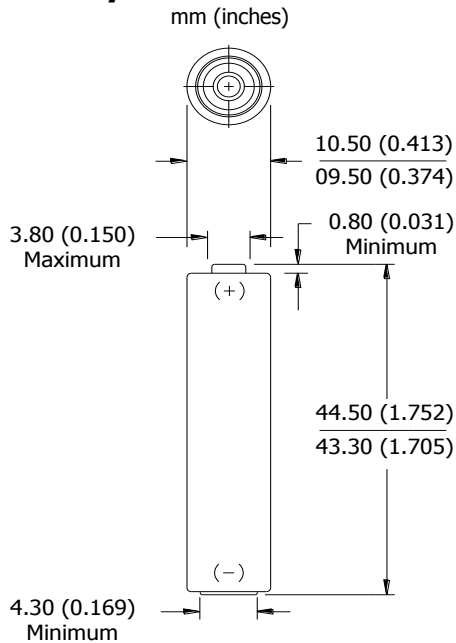

This battery has Underwriters Laboratories component recognition (MH29980)

Milliamp-Hours Capacity

Constant Current Discharge to 0.9 Volts at 21°C

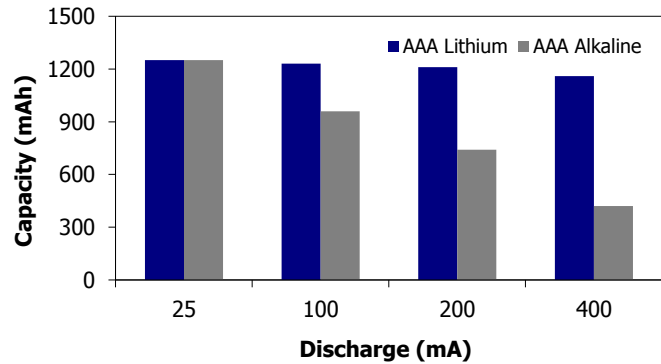

Milliwatt-Hours Capacity at Cold/Room Temperature

Constant Power Discharge to 1.0 Volts at 0°C and 21°C

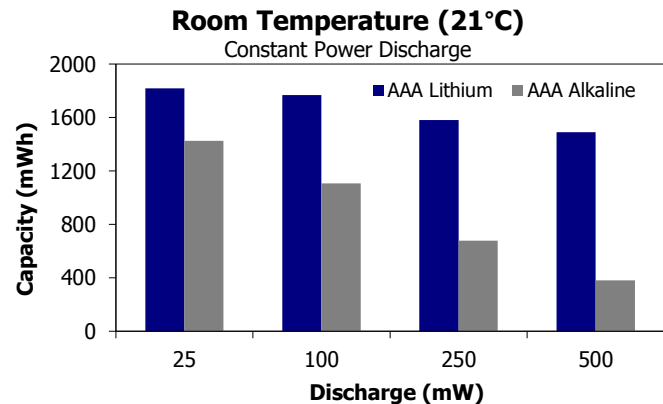
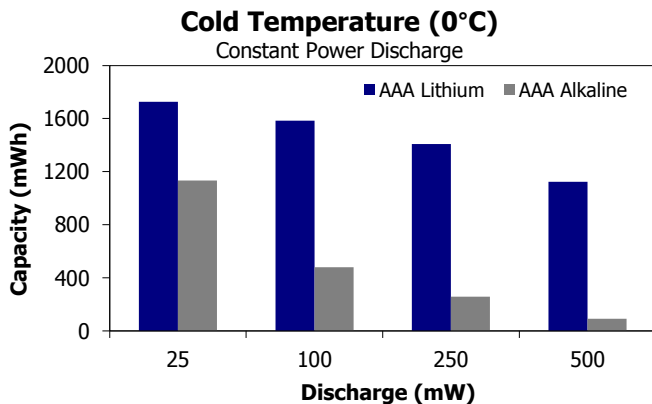

Important Notice

This datasheet contains typical information specific to products manufactured at the time of its publication.
©Energizer Holdings, Inc. - Contents herein do not constitute a warranty.

ENERGIZER L92

AAA

Typical Discharge Curve Characteristics

Constant Current Discharge at 21°C (low and high drains)

Low Drain Performance

50mA Continuous (21°C)

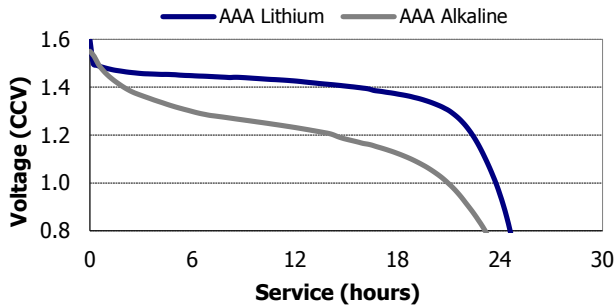

High Drain Performance

600mA Continuous (21°C)

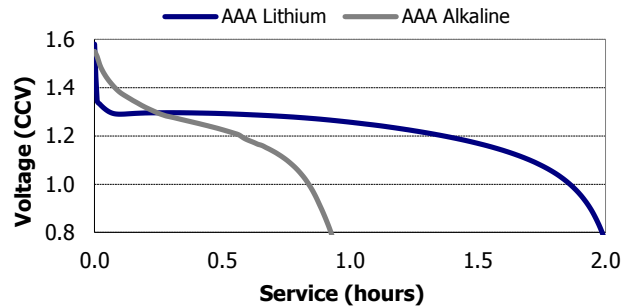

Constant Power Performance

Typical Characteristics to 1.0 Volts (21°C)

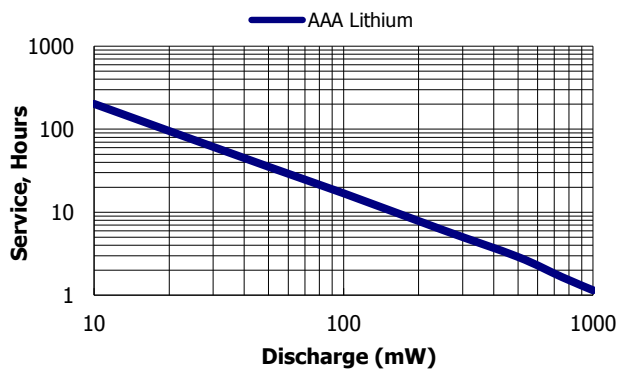

Constant Current Performance

Typical Characteristics to 1.0 Volts (21°C)

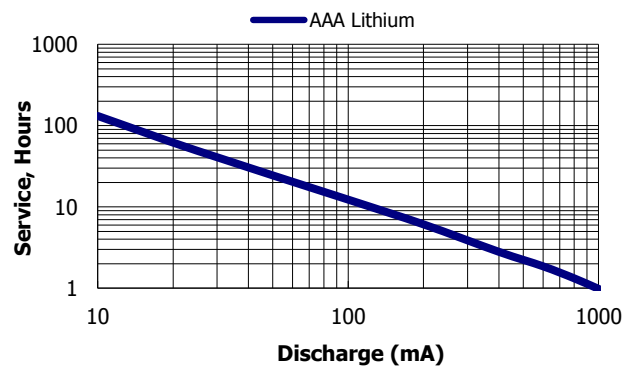

Application Tests (21°C)

ELECTRONIC GAME / DIGITAL AUDIO
100 mA 1 hr/day

REMOTE
24 ohm 15 sec/min 8 hrs/day

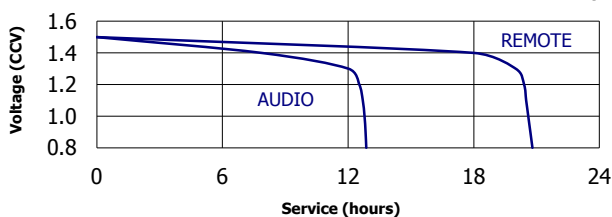

Industry Standard Tests (21°C)

DIGITAL STILL CAMERA (DSC)
.9W/.4W 2/.1/27.9 sec 10x per hour

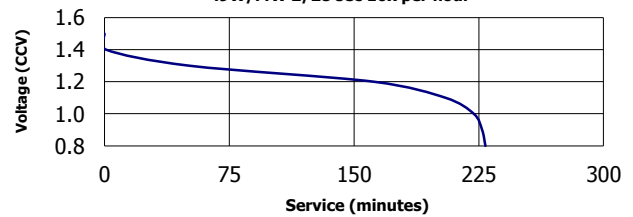

PHOTOFLASH
600 mA 10 sec/min 1 hr/day

PORTABLE LIGHTING
5.1 ohm LIF

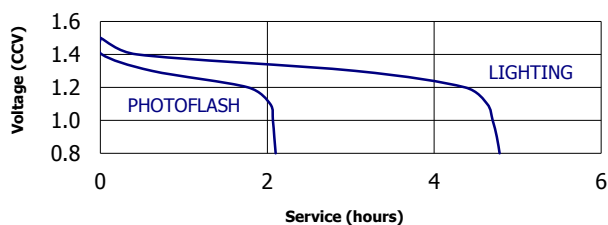

DIGITAL STILL CAMERA (DSC)
1.2/.65 mW 2/.1/27.9 sec 10x per hour

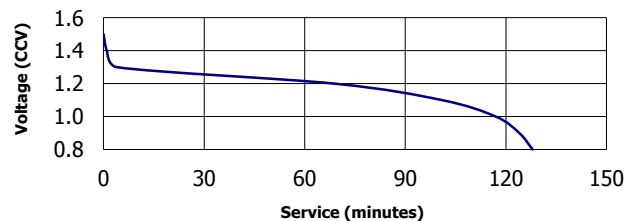

Important Notice

This datasheet contains typical information specific to products manufactured at the time of its publication.

©Energizer Holdings, Inc. - Contents herein do not constitute a warranty.