

SEANNA-A

~2.3° spot beam. Assembly with holder.

TECHNICAL SPECIFICATIONS:

Dimensions	Ø 155.2 mm
Height	82 mm
Fastening	pin, screw
Colour	black
Box size	
Box weight	6.5 kg
Quantity in Box	pcs
ROHS compliant	yes ⓘ



MATERIAL SPECIFICATIONS:

Component	Type	Material	Colour
SEANNA-A	Lens	PMMA	clear
SEANNA-FRES	Lens	PMMA	clear
SEANNA-HLD-B	Holder	PA66GF30	black
SEANNA-HLD-B-TOPRING	Holder	PA66GF30	black
SEANNA-HLD-B-BOTTOMRING	Holder	PA66GF30	black
SEANNA-SCREW	Accessory	Stainless steel	

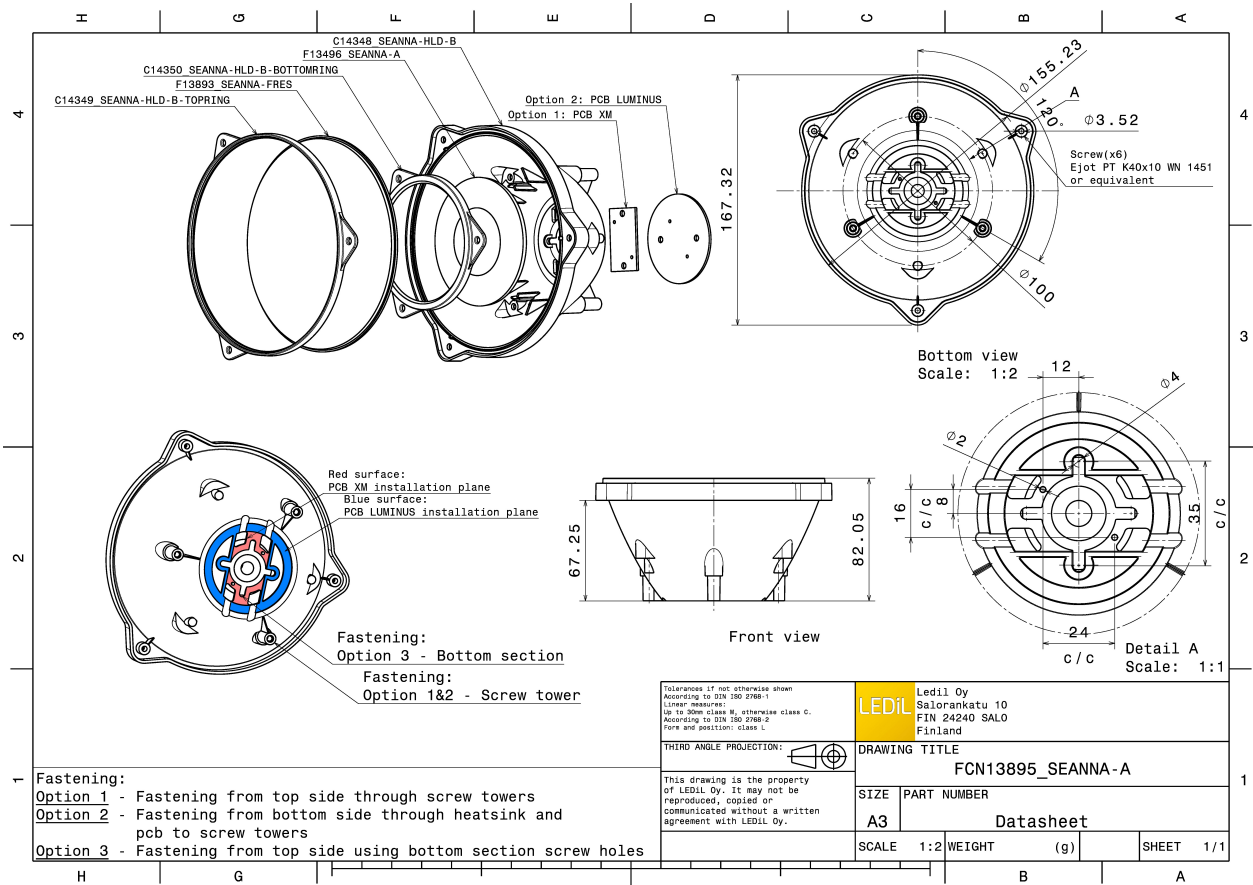

PHOTOMETRIC DATA (MEASURED):



LED XD16
FWHM 1.0°
Efficiency 91 %
Peak intensity 629.000 cd/Im
Required components:

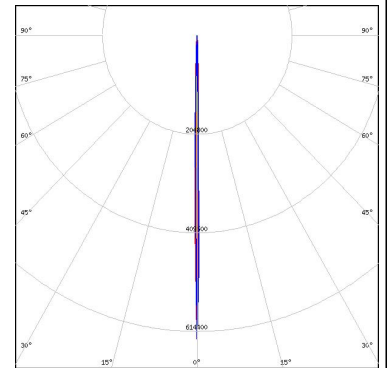
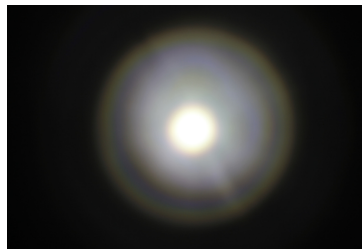

LED XP-E2
FWHM 1.0°
Efficiency %
Peak intensity 750.000 cd/Im
Required components:

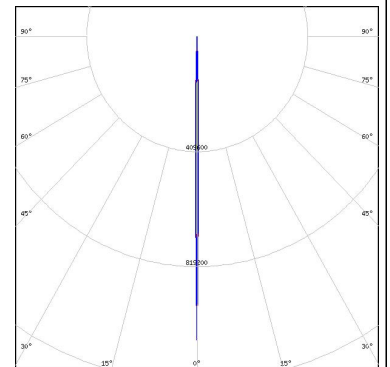

LED XP-L
FWHM 2.4°
Efficiency 94 %
Peak intensity 255.000 cd/Im
Required components:

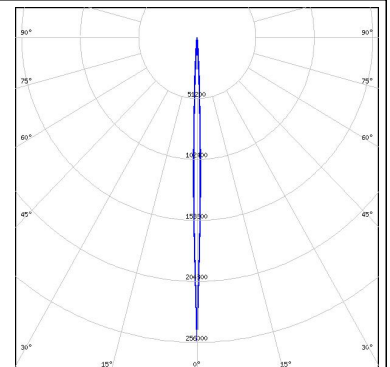
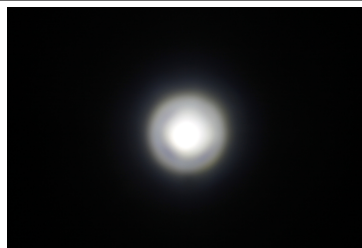

LED XP-L HI
FWHM 1.6°
Efficiency 94 %
Peak intensity 492.000 cd/Im
Required components:

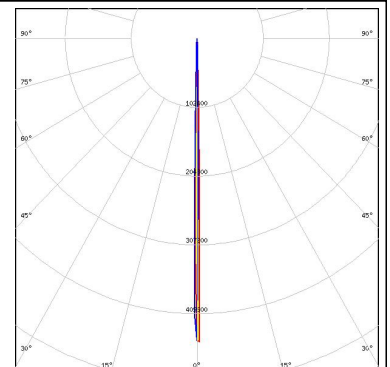

PHOTOMETRIC DATA (MEASURED):

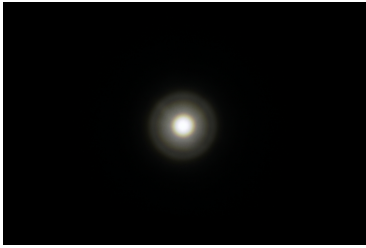
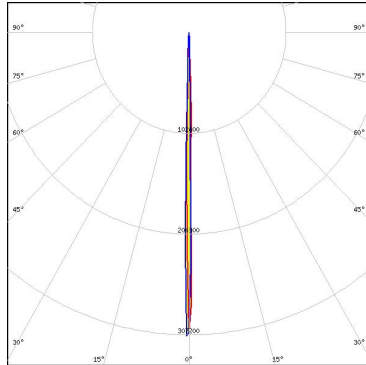
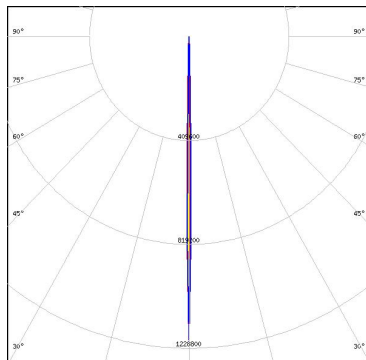
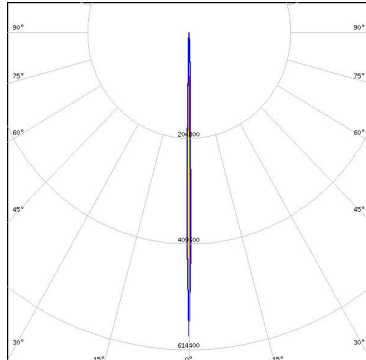
<p>NICHIA</p> <p>LED NVSW3x9A FWHM 1.9° Efficiency 92 % Peak intensity 310.000 cd/lm Required components:</p>		
<p>OSRAM <small>Opto Semiconductors</small></p> <p>LED Oslon Black Flat FWHM 1.2° Efficiency 94 % Peak intensity 1196.000 cd/lm Required components:</p>		
<p>OSRAM <small>Opto Semiconductors</small></p> <p>LED Oslon Square Gen3 FWHM 1.5° Efficiency 94 % Peak intensity 587.000 cd/lm Required components:</p>		

PHOTOMETRIC DATA (SIMULATED):



LED MK-R
FWHM 4.0°
Efficiency 91 %
Peak intensity 82.000 cd/lm
Required components:

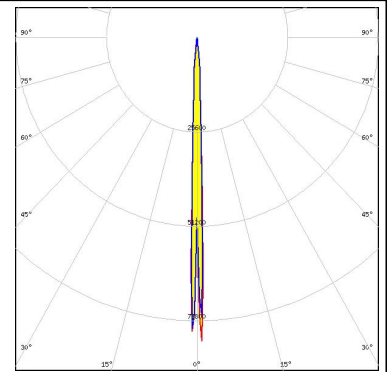

LED XB-D
FWHM 1.3°
Efficiency 87 %
Peak intensity 698.000 cd/lm
Required components:

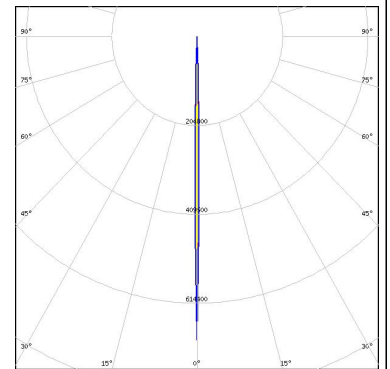

LED XHP35 HD
FWHM 2.4°
Efficiency 89 %
Peak intensity 257.000 cd/lm
Required components:



LED XHP35 HI
FWHM 1.6°
Efficiency 83 %
Peak intensity 496.000 cd/lm
Required components:

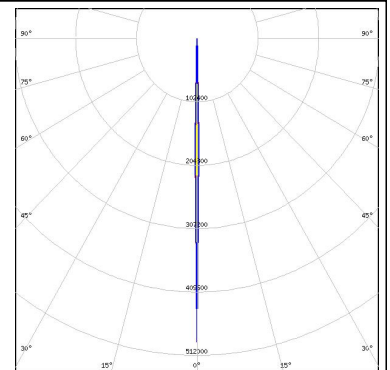

PHOTOMETRIC DATA (SIMULATED):



LED XHP50
FWHM 3.3°
Efficiency 87 %
Peak intensity 122.000 cd/lm
Required components:

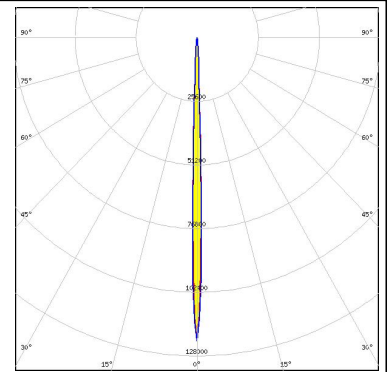

LED XHP70
FWHM 4.3°
Efficiency 81 %
Peak intensity 69.900 cd/lm
Required components:

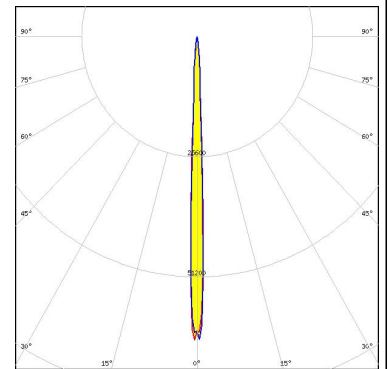

LED XM-L
FWHM 2.4°
Efficiency %
Peak intensity 272.000 cd/lm
Required components:

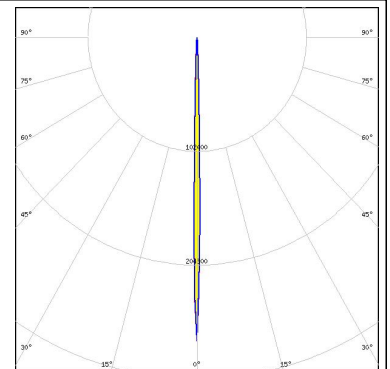

LED XM-L2
FWHM 2.0°
Efficiency 85 %
Peak intensity 275.000 cd/lm
Required components:

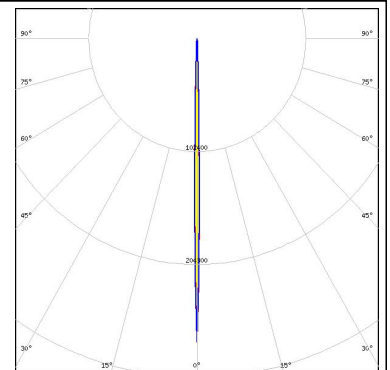

PHOTOMETRIC DATA (SIMULATED):



LED XP-E
FWHM 1.2°
Efficiency 92 %
Peak intensity 955.000 cd/lm
Required components:

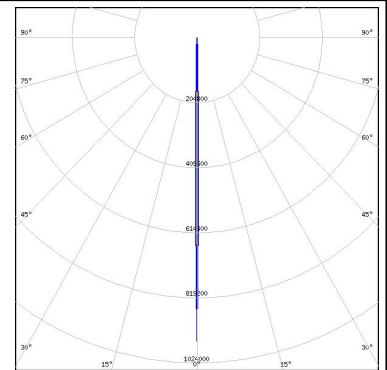

LED XP-G
FWHM 1.4°
Efficiency 90 %
Peak intensity 578.000 cd/lm
Required components:

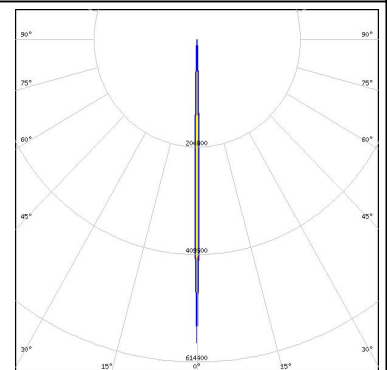

LED XP-G2
FWHM 1.4°
Efficiency 91 %
Peak intensity 628.000 cd/lm
Required components:

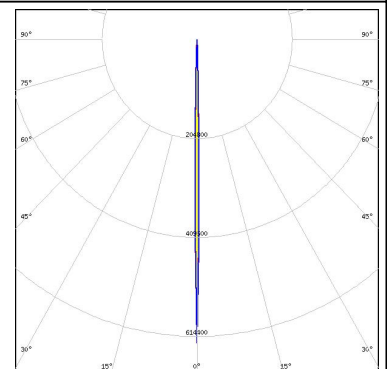

LED XQ-E
FWHM 1.1°
Efficiency 92 %
Peak intensity 1460.000 cd/lm
Required components:

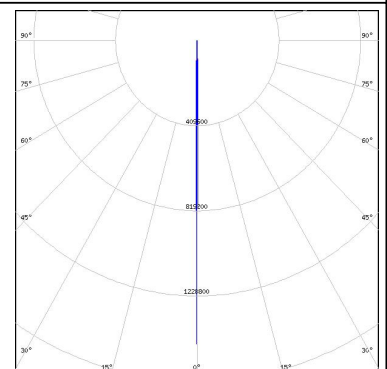

PHOTOMETRIC DATA (SIMULATED):



LED XQ-E HI
FWHM 1.2°
Efficiency 90 %
Peak intensity 1300.000 cd/lm
Required components:



LED XT-E
FWHM 1.4°
Efficiency 88 %
Peak intensity 519.000 cd/lm
Required components:

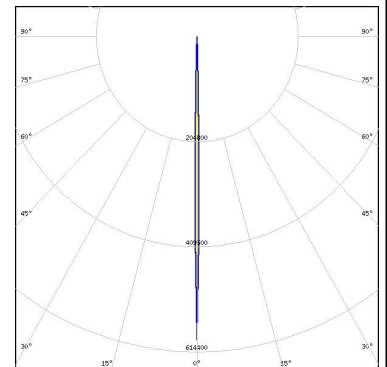

LED LZ4 (00xW00)
FWHM 3.3°
Efficiency 91 %
Peak intensity 136.000 cd/lm
Required components:

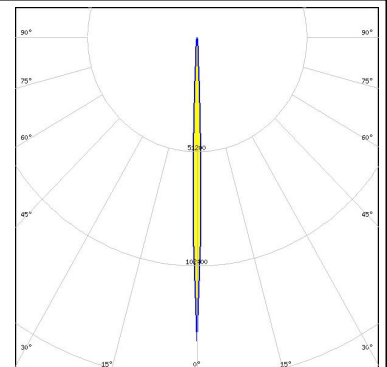



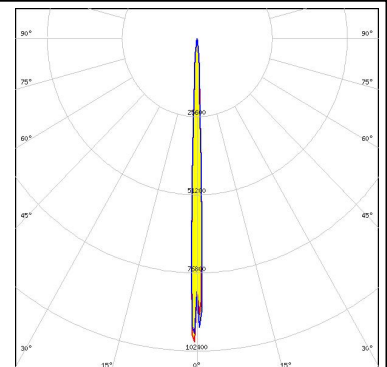

LED LUXEON M/MX
FWHM 3.6°
Efficiency 89 %
Peak intensity 99.000 cd/lm
Required components:

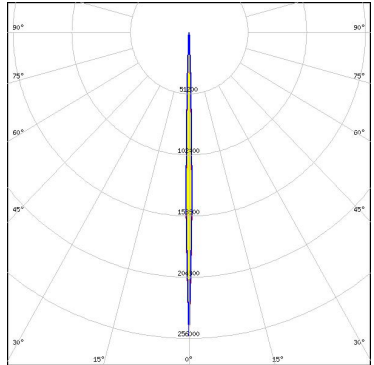

PHOTOMETRIC DATA (SIMULATED):

<p>LUMILEDS</p> <p>LED: LUXEON MZ</p> <p>FWHM: 2.2°</p> <p>Efficiency: 84 %</p> <p>Peak intensity: 151.040 cd/lm</p> <p>Required components:</p>	
<p>LUMILEDS</p> <p>LED: LUXEON Rebel</p> <p>FWHM: 1.3°</p> <p>Efficiency: 90 %</p> <p>Peak intensity: 704.000 cd/lm</p> <p>Required components:</p>	
<p>LUMILEDS</p> <p>LED: LUXEON Rebel ES</p> <p>FWHM: 1.6°</p> <p>Efficiency: 90 %</p> <p>Peak intensity: 530.000 cd/lm</p> <p>Required components:</p>	
<p>LUMILEDS</p> <p>LED: LUXEON S1000</p> <p>FWHM: 3.8°</p> <p>Efficiency: 88 %</p> <p>Peak intensity: 100.000 cd/lm</p> <p>Required components:</p>	

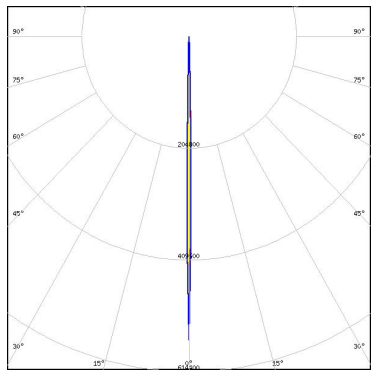
PHOTOMETRIC DATA (SIMULATED):

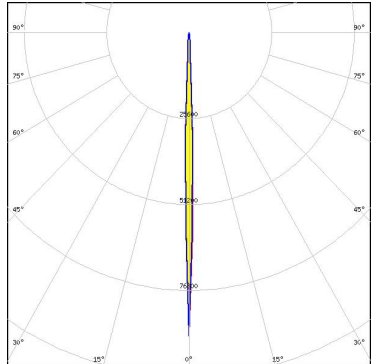
<p> LED SBT-90 FWHM 2.3° Efficiency 90 % Peak intensity 253.000 cd/lm Required components:</p>	
<p> LED Oslon Square PC FWHM 1.5° Efficiency 89 % Peak intensity 550.000 cd/lm Required components:</p>	
<p> LED Z8Y50P FWHM 3.0° Efficiency 79 % Peak intensity 90.400 cd/lm Required components:</p>	

GENERAL INFORMATION:

NOTE: The typical beam angle will be changed by different color, chip size and chip position tolerance. The typical total beam angle is the full angle measured where the luminous intensity is half of the peak value.

MATERIALS:

As part of our continuous research and improvement processes, and to ensure the best possible quality and availability of our products, LEDiL reserves the right to change material grades without notice.

PRODUCT DATA USER AGREEMENT AND DISCLAIMER:

The measured data in the provided downloadable LEDiL Product Datasheets and Mechanical 2D-Drawings is rounded and provided as reference for planning. LEDiL Oy's optical specifications have been verified by conducting performance testing of the products in accordance with the company's quality system. The reported data are averaged results of multiple measurements with typical variation. LEDiL Oy reserves the right to without prior notification make changes and improvements to its products.

LEDiL Oy assumes neither warranty, nor guarantee nor any other liability of any kind for the contents and correctness of the provided data. The provided data has been generated with highest diligence but the provided data may in reality not represent the complete possible variation range of all intrinsic parameters. Therefore, in certain cases a deviation from the provided data could occur.

LEDiL Oy reserves the right to undertake technical changes of its products without further notification which could lead to changes in the provided data. LEDiL Oy assumes no liability of any kind for the possible deviation from any provided data or any other damage resulting from the usage of the provided data.

The user agrees to this disclaimer and user agreement with the download or usage of the provided files.

LEDiL Oy

Joensuunkatu 13
FI-24240 SALO
Finland

LEDiL Inc.

228 West Page Street
Suite D
Sycamore IL 60178
USA

Local sales and technical support

[www.ledil.com/
where_to_buy](http://www.ledil.com/where_to_buy)

Shipping locations

Salo, Finland
Hong Kong, China

Distribution Partners

[www.ledil.com/
where_to_buy](http://www.ledil.com/where_to_buy)