

**FT2/FU2 Relay**

- Telecom/signal relay (dry circuit, test access, ringing)
- Slim line 15x7.5mm (.59x.295")
- Switching current 2A
- 2 form C bifurcated contacts (2 CO)
- High sensitive 24V and 48V coil versions
- Meets Telcordia GR 1089, FCC Part 68 and ITU-T K20, ≥ 2500V between coil and contacts

Typical applications

Communications equipment, linecard application – analog, ISDN, xDSL, PABX, voice over IP, office and business equipment, measurement and control equipment, consumer electronics, set top boxes, HiFi, medical equipment

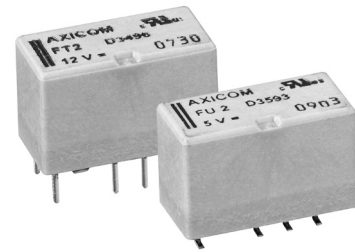

**Approvals**

UL 508 File No. E 111441  
Technical data of approved types on request

**Contact Data**

Contact arrangement	2 Form C (CO)
Max. switching voltage	220VDC, 250VAC
Rated current	2A
Limiting continuous current	2A
Switching power	60W, 62.5VA
Contact material	PdRu, Au covered
Contact style	twin contacts
Min. recommended contact load	100µV/1µA
Initial contact resistance	<70mΩ
Thermoelectric potential	<10µV
Operate time	typ. 3ms, max. 5ms
Release time	
without diode in parallel	typ. 2ms, max. 5ms
with diode in parallel	typ. 4ms, max. 5ms
Bounce time max.	typ. 1ms, max. 5ms
Electrical endurance	
at contact application 0 (≤ 30mV/≤10mA)	min. 2.5x10 <sup>6</sup> operations
cable load open end	min. 2.0x10 <sup>6</sup> operations
resistive, 24V / 1.25A - 30W	min. 1x10 <sup>5</sup> operations
resistive, 30VDC / 2A - 60W	min. 1x10 <sup>5</sup> operations
resistive, 125VDC / 0.24A - 30W	min. 1x10 <sup>5</sup> operations
Contact ratings, UL contact rating	220VDC, 0.24A, 60W 125VDC, 0.24A, 30W 250VAC, 0.25A, 62.5VA 125VAC, 0.5A, 62.5VA 30VDC, 2A, 60W
Mechanical endurance	100x10 <sup>6</sup> operations

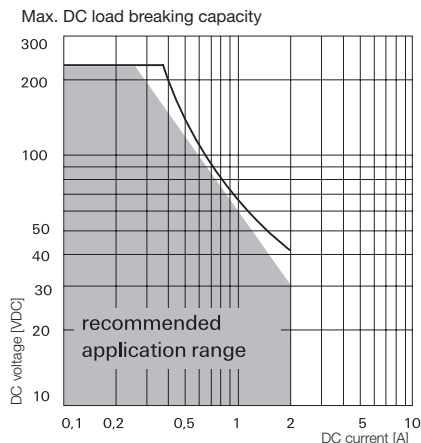

**Coil Data**

Magnetic system	monostable, non polarized
Coil voltage range	3 to 48VDC
Max. coil temperature	150°C
Thermal resistance	<125K/W

**Coil versions, monostable**

Coil code	Rated voltage VDC	Operate voltage VDC <sub>min.</sub>	Limiting voltage VDC <sub>max.</sub>	Release voltage VDC <sub>min.</sub>	Coil resistance Ω±10%	Rated coil power mW
<b>Standard version, monostable</b>						
21	3	2.25	6.80	0.30	45	200
29	4	3.00	9.00	0.40	80	200
22	4.5	3.38	10.10	0.45	101	200
23	5	3.75	11.20	0.50	125	200
24	6	4.50	13.50	0.60	180	200
25	9	6.75	20.30	0.90	405	200
26	12	9.00	27.00	1.20	720	200
27	24	18.00	47.50	2.40	2400	240
28	48	36.00	95.00	4.80	9600	240

**High dielectric version, monostable**

91	3	2.25	6.80	0.30	45	200
92	4.5	3.38	10.10	0.45	101	200
93	5	3.75	11.20	0.50	125	200
96	12	9.00	27.00	1.20	720	200
97	24	18.00	47.50	2.40	2400	240

All figures are given for coil without pre-energization, at ambient temperature +23°C. Other coil voltages on request.

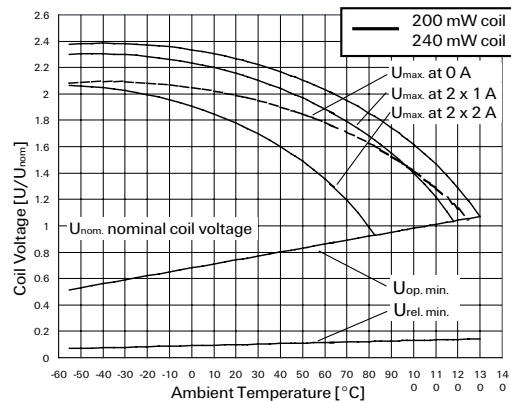

**FT2/FU2 Relay (Continued)**

**Coil Data (continued)**

**Coil versions, monostable**

Coil code	Rated voltage VDC	Operate voltage VDC <sub>min.</sub>	Limiting voltage VDC <sub>max.</sub>	Release voltage VDC <sub>min.</sub>	Coil resistance Ω±10%	Rated coil power mW
71	3	2.25	5.50	0.30	30	300
73	5	3.75	9.20	0.50	83	300
76	12	9.00	22.10	1.20	480	300

**High dielectric Australia version, monostable**

71	3	2.25	5.50	0.30	30	300
73	5	3.75	9.20	0.50	83	300
76	12	9.00	22.10	1.20	480	300

All figures are given for coil without pre-energization, at ambient temperature +23°C. Other coil voltages on request.

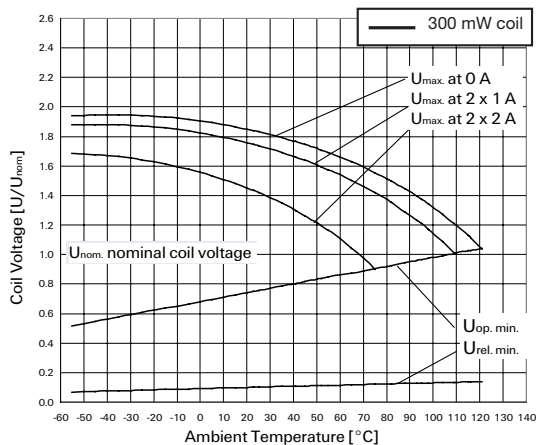

U<sub>max</sub> upper limit of the operative range of the coil voltage (limiting voltage) when coils are continuously energized

U<sub>op.min</sub> lower limit of the operative range of the coil voltage (reliable operate voltage)

U<sub>rel.min</sub> lower limit of the operative range of the coil voltage (reliable release voltage)

**Terminal assignment**

TOP view on component side of PCB

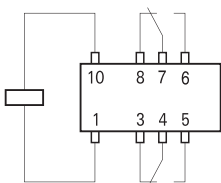

**PCB layout**

TOP view on component side of PCB

**THT version**

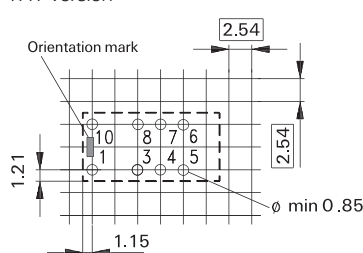

**SMT, long terminals**

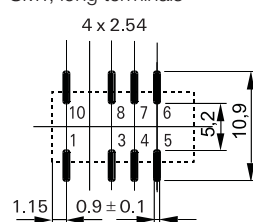

**SMT, short terminals**

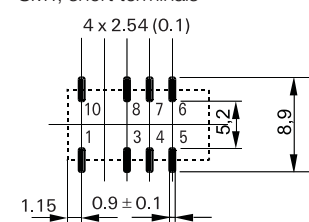

**Insulation**

	standard	high dielectric*
Initial dielectric strength		
between open contacts	1000V <sub>rms</sub>	1500V <sub>rms</sub>
between contact and coil	1500V <sub>rms</sub>	4000V <sub>rms</sub>
between adjacent contacts	1500V <sub>rms</sub>	1800V <sub>rms</sub>
Initial surge withstand voltage		
between open contacts	1500V	2500V
between contact and coil	2500V	5000V
between adjacent contacts	1500V	2500V
Initial insulation resistance		
between insulated elements	>10 <sup>9</sup> Ω	>10 <sup>9</sup> Ω
Capacitance		
between open contacts		max. 4pF
between contact and coil		max. 1pF
between adjacent contacts		max. 1pF
Cross talk at 100MHz/900MHz		-30.6dB/-13.7dB
Insertion loss at 100MHz/900MHz		-0.02dB/-0.50dB
Voltage standing wave ratio (VSWR) at 100MHz/900MHz		1.02 / 1.27

\*this relay contains SF6 (Sulfur hexafluoride, CAS number: 2551-62-4) for dielectric strength enhancement, SF6 is hermetically sealed in relay without leaks to air during normal application as recommended per the applicable product specification. It is clarified that the usage of SF6 in mini signal relay is not prohibited by related regulations. Please contact TE local sales or field engineer for further information and detailed material declaration.

**Other Data**

Material compliance: EU RoHS/ELV, China RoHS, REACH, Halogen content refer to the Product Compliance Support Center at [www.te.com/customer-support/rohssupportcenter](http://www.te.com/customer-support/rohssupportcenter)

Ambient temperature	-55°C to +85°C
Thermal resistance	<125K/W
Category of environmental protection IEC 61810	RT III - wash tight
Vibration resistance (functional)	10g, 10 to 500Hz
Shock resistance (functional), half sinus 11ms	15g
Shock resistance (destructive), half sinus 0.5ms	500g
Weight	max. 3g
Resistance to soldering heat THT IEC 60068-2-20	265°C/5s
For all High Dielectric Versions (HDV)	260°C/5s
Moisture sensitive level, JEDEC J-Std-020D	MSL3
related only to SMT and THT-HDV relays packed in original dry-packs	
Ultrasonic cleaning	not recommended
Packaging/unit	
THT version	tube/50 pcs., box/2000 pcs.
SMT short terminals	reel/500 pcs., box/2500 pcs.
SMT long terminals	reel/400 pcs., box/2000 pcs.

**FT2/FU2 Relay (Continued)**

**Dimensions**

THT version

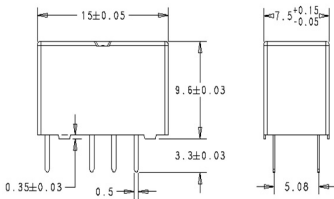

SMT, long terminals

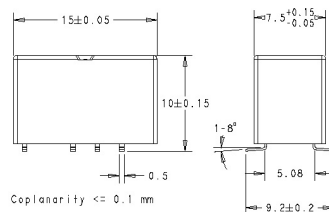

SMT, short terminals

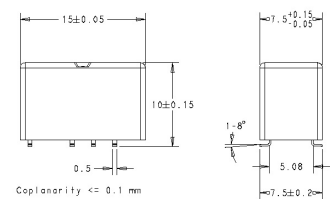

**Processing**

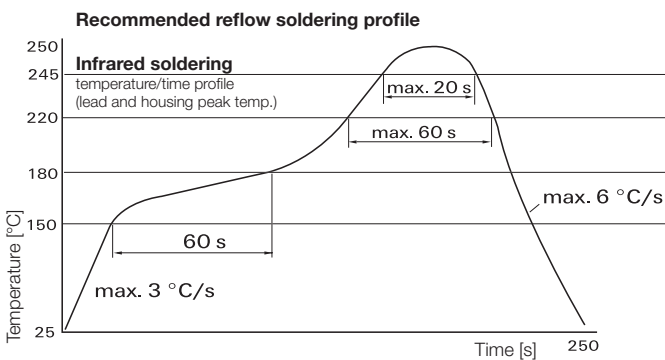
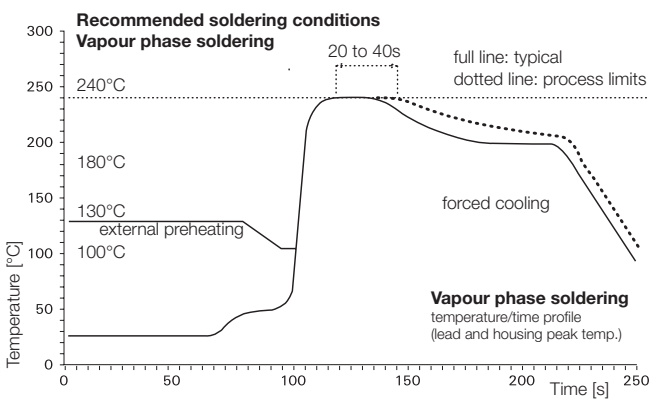

FT2/FU2 Relay (Continued)

Packing

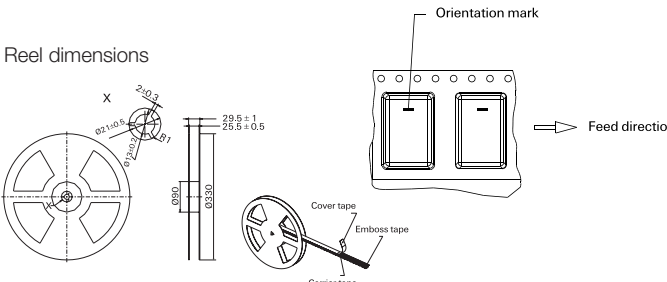
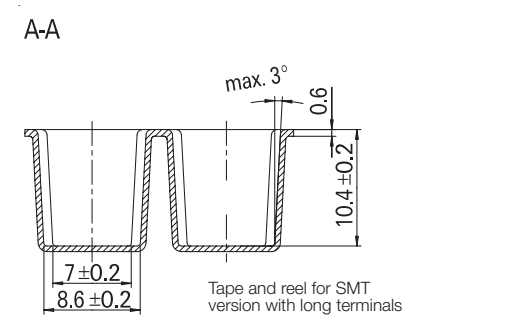
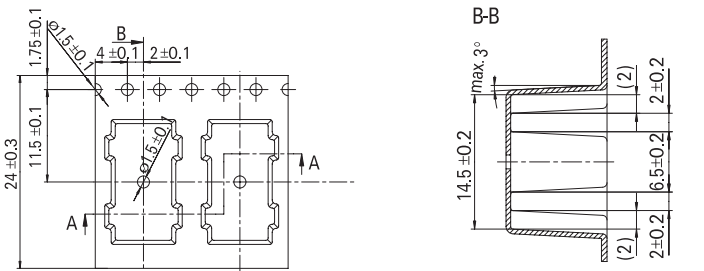
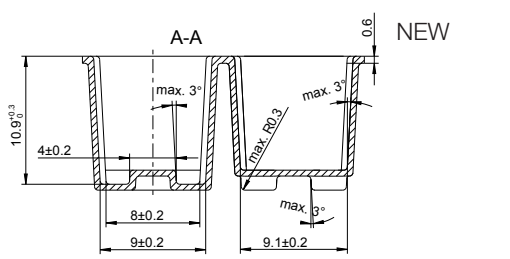
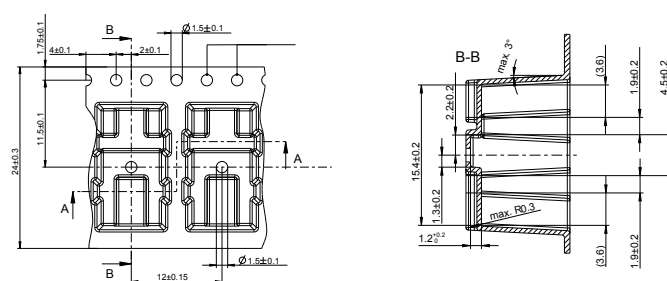
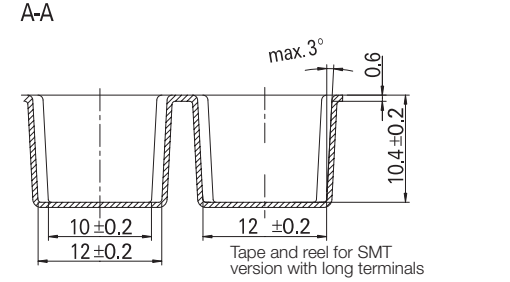
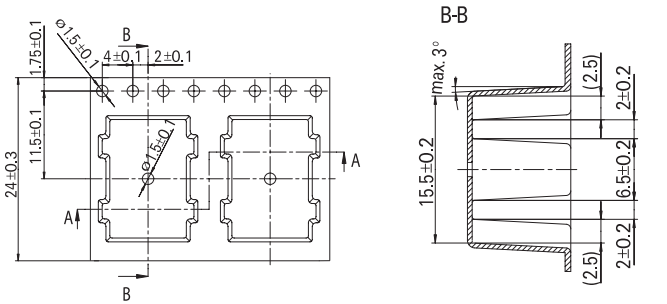
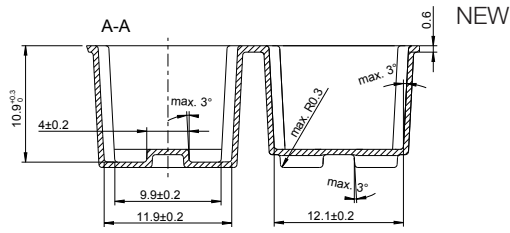
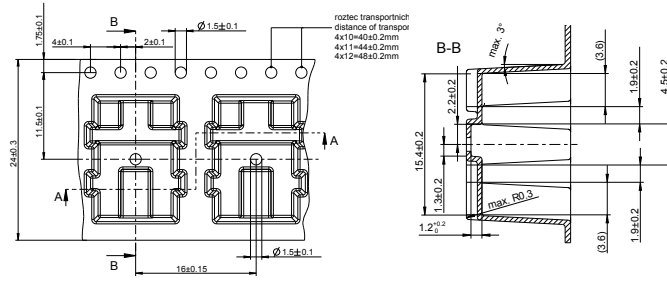
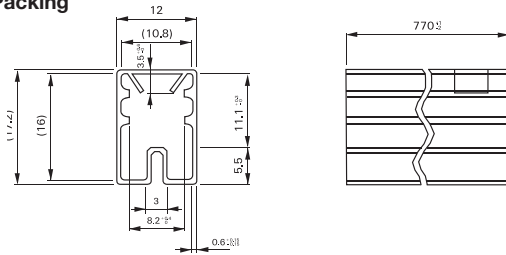

**FT2/FU2 Relay** (Continued)

<b>Product code structure</b>		Typical product code	<b>D34</b>	<b>02</b>
<b>Type</b>	<p><b>D34</b> Signal Relays FT2 (THT)  <b>D35</b> Signal Relays FU2 (SMT)          2 form C, 2 CO</p>			
<b>Coil</b>	<p>Coil code: please refer to coil versions table          Performance and coil type  <b>2x</b> Standard version, monostable  <b>9x</b> High dielectric version, monostable  <b>7x</b> High dielectric, Australia version, monostable (SMT version only)</p>			
<b>Terminals</b>	<p><b>Blank</b> THT, Standard packaging  <b>L</b> THT, dry-pack (on request)  <b>N</b> SMT, short pins  <b>W</b> SMT, long pins</p>			

Product code	Arrangement	Perf. type	Coil type	Coil	Terminals	Part Number
D3421	2 form C (2 CO)	Standard	Monostable	3VDC	THT	1462035-9
D3423				5VDC		1-1462035-1
D3426				12VDC		1-1462035-4
D3427				24VDC		1-1462035-7
D3523N	2 form C (2 CO)	Standard	Monostable	5VDC	SMT short	2-1462036-1
D3527N				24VDC		2-1462036-9
D3528N				48VDC		9-1462036-3
D3521W	2 form C (2 CO)	Standard	Monostable	3VDC	SMT long	1-1462036-8
D3522W				4.5VDC		2-1462036-0
D3523W				5VDC		2-1462036-2
D3526W				12VDC		2-1462036-8
D3527W				24VDC		9-1462036-1
D3491	2 form C (2 CO)	High dielectric	Monostable	3V	THT	2-1462035-0
D3492				4.5VDC		2-1462035-1
D3493				5V		1-1462035-5
D3496				12VDC		2-1462035-4
D3497				24VDC		2-1462035-5
D3491L				3VDC		2-1462035-7
D3491L	2 form C (2 CO)	High dielectric special	Monostable	3VDC	THT	3-1462035-0

Other types on request

This list represents the most common types and does not show all variants covered by this data sheet.