

MOUNTING PLATE SIZE

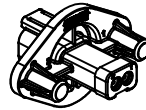

SHOWN WITH END CAP

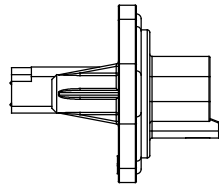
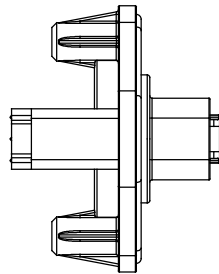
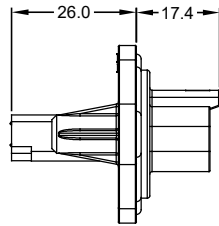
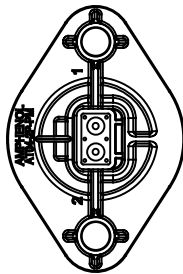
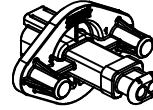

SHOWN WITH STRAIN RELIEF

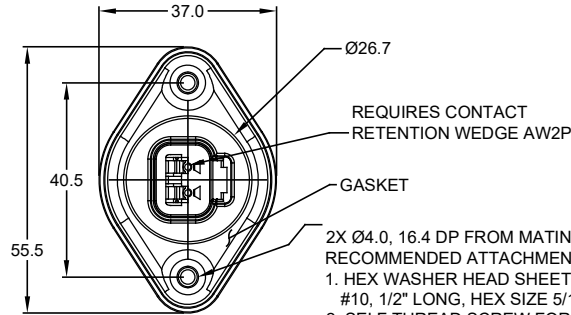

- 2X Ø4.0, 16.4 DP FROM MATING SURFACE
 RECOMMENDED ATTACHMENT OPTIONS:
 1. HEX WASHER HEAD SHEETMETAL SCREW, #10, 1/2" LONG, HEX SIZE 5/16".
 2. SELF THREAD SCREW FOR PLASTIC SUCH AS ST 4.8

REVISIONS					
REV	ECO	DESCRIPTION	DATE	BY	APPR
A1	-	RELEASED CHARTED DRAWING	21MAR18	JAH	-

NOTES: UNLESS OTHERWISE SPECIFIED

- MATERIAL:
 HOUSING: THERMOPLASTIC; COLOR: BLACK
 END CAP: THERMOPLASTIC; COLOR: BLACK
 STRAIN RELIEF CAP: THERMOPLASTIC; COLOR: BLACK
 SEALS: SILICONE RUBBER; COLOR: RED
- MODIFICATIONS: FLANGE, GASKET, END CAP (OPT), STRAIN RELIEF CAP (OPT), REDUCED DIAMETER SEAL (OPT).
- SPECIFICATIONS:
 3.1 CURRENT RATING: 13 AMPS
 3.2 OPERATING TEMPERATURE: -55°C TO +125°C
 3.3 DIELECTRIC WITHSTANDING VOLTAGE: LESS THAN 2 MILLIAMPS CURRENT LEAKAGE @ 1500 VOLTS AC.
 3.4 INSULATION RESISTANCE: 1000 MEGOHMS MIN @ 25°C.
 3.5 MOISTURE RESISTANCE: IP67 (MATED CONDITION)
 3.6 MATING CYCLE DURABILITY: 100 CYCLES
 3.7 RoHS COMPLIANT
- MATING PART: AT06-2S* PLUG
 (* = MODIFICATIONS)
- ALL DIMENSIONS ARE FOR REFERENCE USE ONLY.

△ CONTACT SIZE AND REAR SEAL WIRE RANGE:

REDUCED DIAMETER SEAL:

CONTACT SIZE	MIN. INSUL O.D.	MAX. INSUL O.D.	TYPICAL WIRE RANGE
16	1.35 mm (.053 in)	3.05 mm (.120 in)	14 - 20 AWG

STANDARD SEAL:

CONTACT SIZE	MIN. INSUL O.D.	MAX. INSUL O.D.	TYPICAL WIRE RANGE
16	2.24 mm (.088 in)	3.68 mm (.145 in)	14 - 20 AWG

MODIFICATIONS			
PART NUMBER	SEAL	END CAP	STRAIN RELIEF
AT04-2P-PM11	STANDARD	NO	NO
AT04-2P-PM12	REDUCED DIA.	NO	NO
AT04-2P-PM13	STANDARD	YES	NO
AT04-2P-PM14	REDUCED DIA.	YES	NO
AT04-2P-PM15	STANDARD	NO	YES
AT04-2P-PM16	REDUCED DIA.	NO	YES

AT04-2P-PM1X			
QUANTITY	PART NUMBER	DESCRIPTION	ITEM
MATERIALS LIST			
UNLESS OTHERWISE SPECIFIED: 1) All dimensions are in metric (mm). 2) Tolerances are as follows: 1 PL DEC ±0.30 2 PL DEC ±0.15 3 PL DEC ±0.08 Fractions ±1/64 Angles ±1° 3) Note reference = △		SIGNATURES: J. HEAD DATE: 21MAR2018	
MATERIAL SPECIFICATIONS:		APPROVAL:	
PROCESS SPECIFICATIONS:		CUSTOMER:	
NEXT ASSY:		THIS DRAWING IS SUPPLIED FOR INFORMATION ONLY. DESIGN FEATURES, SPECIFICATIONS AND PERFORMANCE DATA SHOWN HEREON ARE THE PROPERTY OF THE AMPHENOL CORPORATION. NO RIGHTS OF REPRODUCTION ARE IMPLIED. ALL DIMENSIONS ARE SUBJECT TO NORMAL MANUFACTURING VARIATIONS.	
SCALE: NONE		 Sine Systems - www.amphenol-sine.com 44724 Morley Drive Clinton Township, MI 48036 RECEPTACLE, 2 PIN, AT SERIES, W/FLANGE, GASKET SIZE: B C- DWG NO: AT04-2P-PM1X REVISION: A1 SHEET 1 OF 1	

TITLE: RECEPTACLE, 2 PIN, AT SERIES, W/FLANGE, GASKET
 DWG NO: AT04-2P-PM1X
 REV: A1
 SH: 1
 OF: 1