

Xinger®

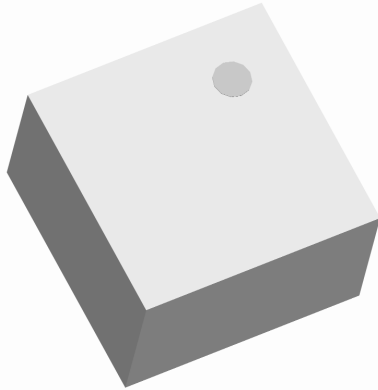

Ultra Low Profile 0404 Balun 50Ω to 50Ω Balanced

Description

The BD3238N5050AHF is a low cost, low profile sub-miniature unbalanced to balanced transformer designed for differential inputs and output locations on modern chipsets in an easy to use surface mount package covering 3200MHz to 3800MHz. The BD3238N5050AHF is ideal for high volume manufacturing and delivers higher performance than traditional ceramic baluns. The BD3238N5050AHF has an unbalanced port impedance of 50Ω and a 50Ω balanced port impedance. This transformation enables single ended signals to be applied to differential ports on modern integrated chipsets. The output ports have equal amplitude (-3dB) with 180 degree phase differential. The BD3238N5050AHF is available on tape and reel for pick and place high volume manufacturing.

Detailed Electrical Specifications: Specifications subject to change without notice.

Features:	Parameter	ROOM (25°C)						Unit
		Min.	Typ.	Max	Min.	Typ.	Max	
<ul style="list-style-type: none"> • 3200 – 3800 MHz • 0.57 mm Height Profile • 50 Ohm to 2 x 25 Ohm • Low Insertion Loss • Surface Mountable • Tape & Reel • Non-conductive Surface • RoHS Compliant • Halogen Free 	Frequency	3200		3800	3400		3600	MHz
	Unbalanced Port Impedance		50			50		Ω
	Balanced Port Impedance		50			50		Ω
	Return Loss	7	11		8	12		dB
	Insertion Loss*		0.9	1		0.7	1	dB
	Amplitude Balance		0.6	1.5		0.4	1.5	dB
	Phase Balance		3	6		3	6	Degrees
	CMRR		28			30		dB
	Power Handling @85C			1.0			1.0	Watts
	Power Handling @105C			0.6			0.6	Watts
	Operating Temperature		-55		+105	-55		+105

* Insertion Loss stated at room temperature (Insertion Loss is approximately 0.1 dB higher at +85 °C)

Outline Drawing

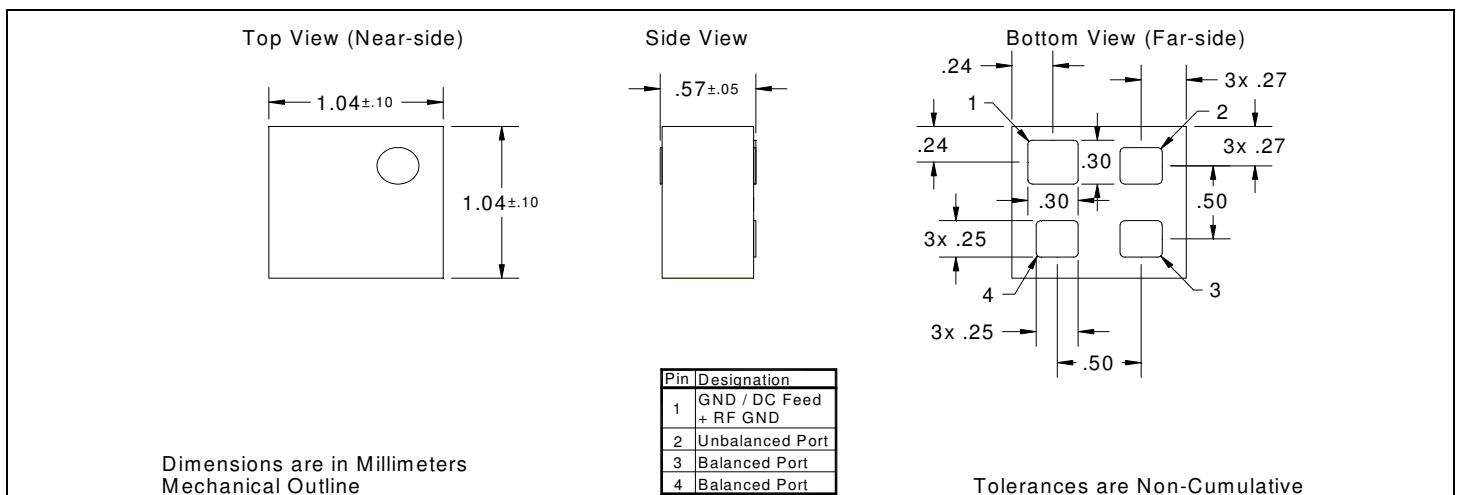

Typical Performance: 3100 MHz. to 39000 MHz.

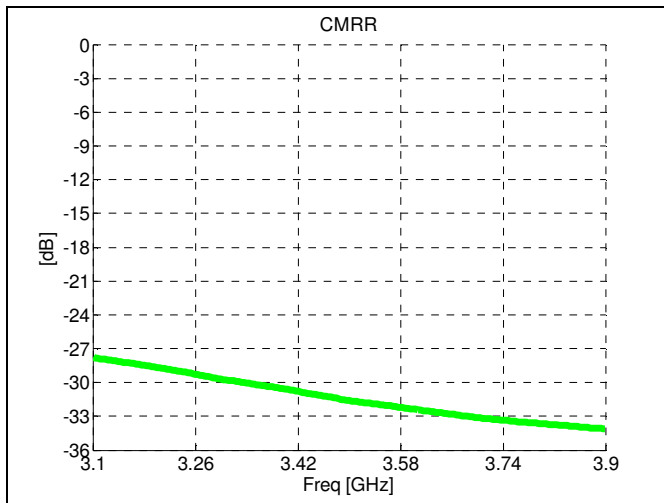
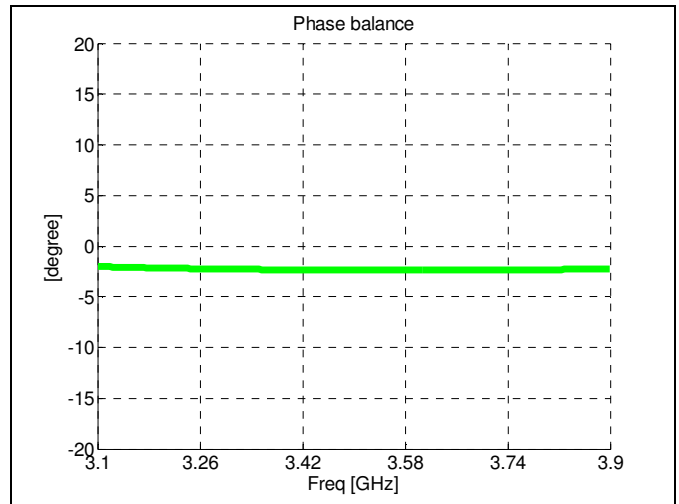
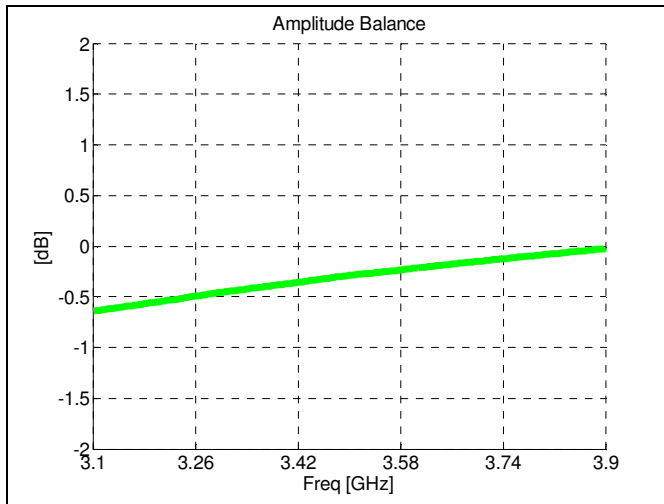
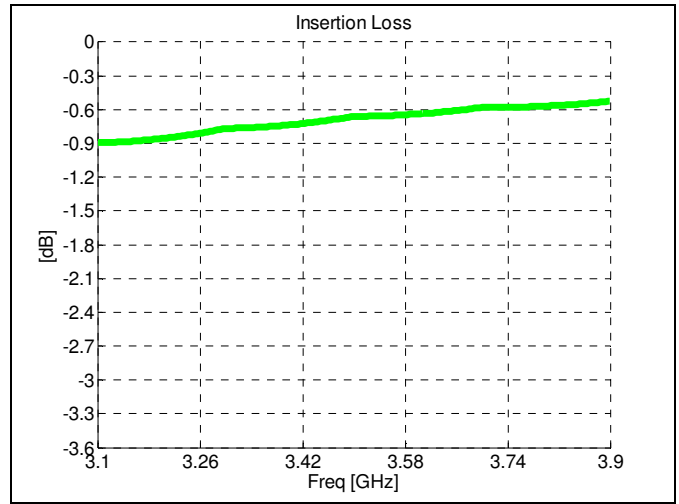
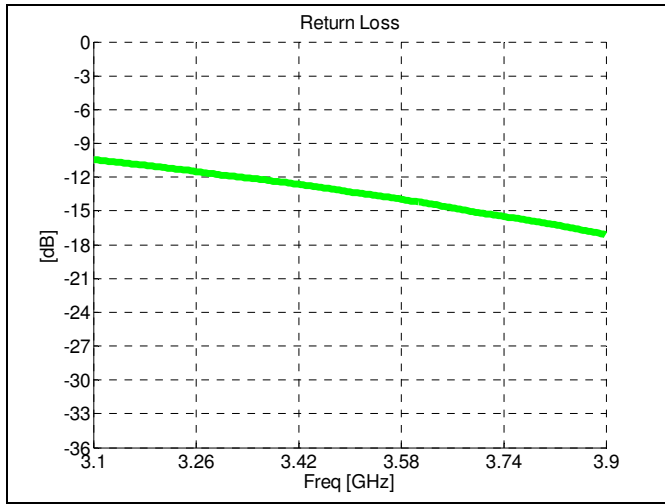

Wide Band Performance: 500 MHz. to 8500 MHz.

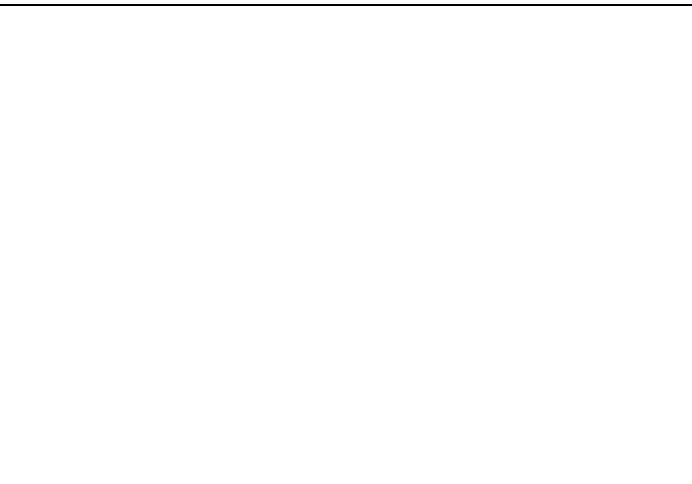
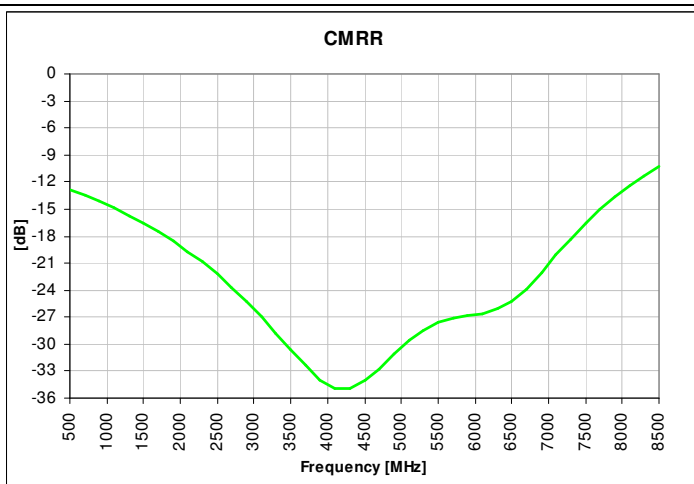
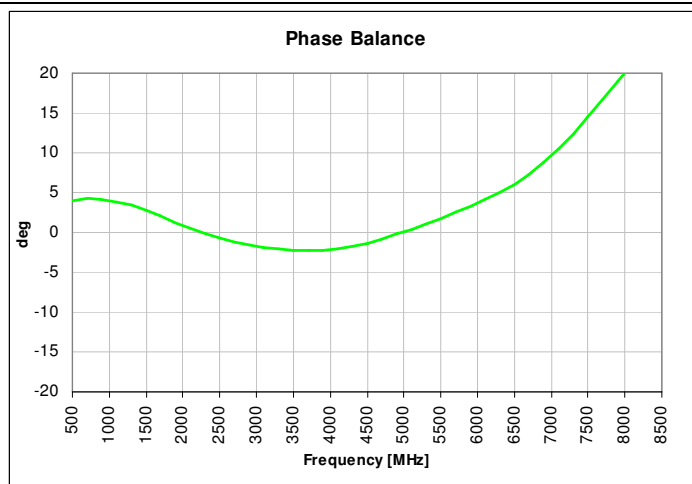
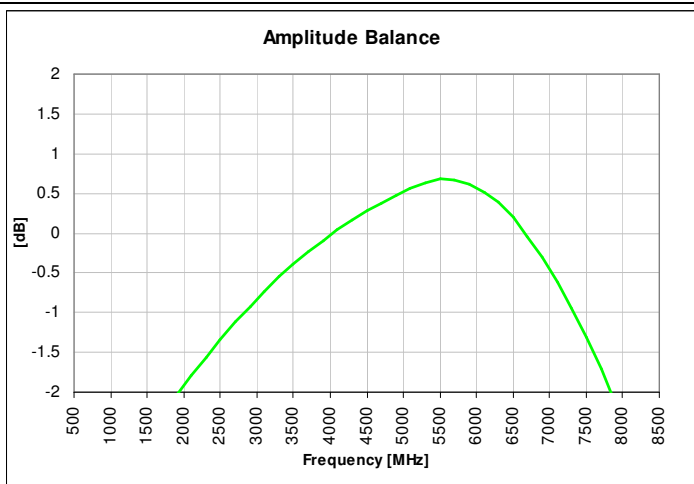
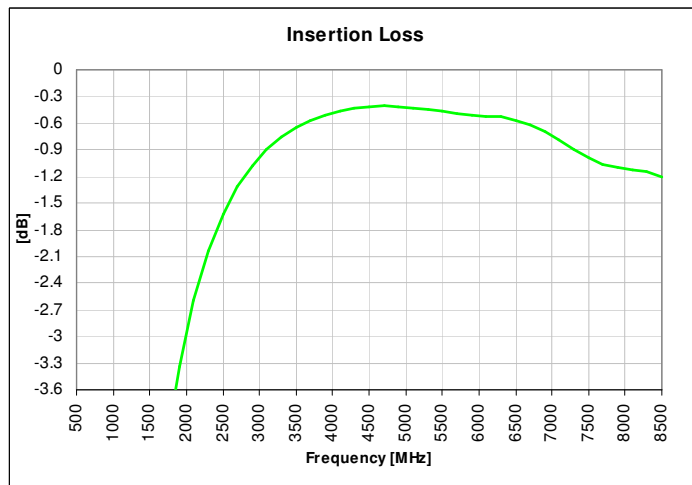
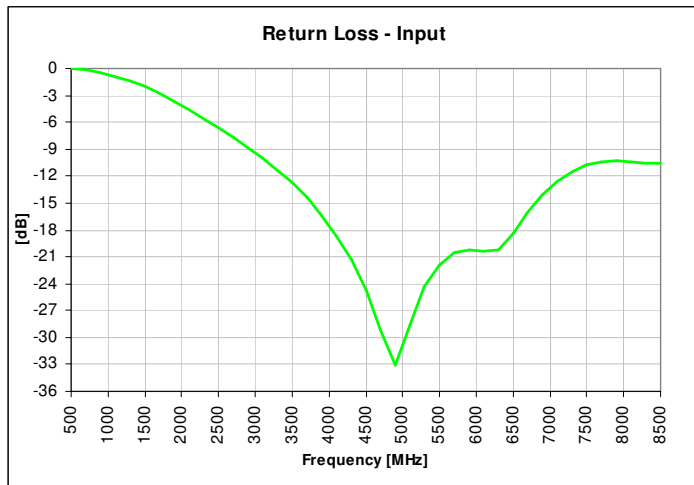

Mounting Configuration:

In order for Xinger surface mount components to work optimally, the proper impedance transmission lines must be used to connect to the RF ports. If this condition is not satisfied, insertion loss, Isolation and VSWR may not meet published specifications.

All of the Xinger components are constructed from organic PTFE based composites which possess excellent electrical and mechanical stability. Xinger components are compliant to a variety of ROHS and Green standards and ready for Pb-free soldering processes. Pads are Gold plated with a Nickel barrier.

An example of the PCB footprint used in the testing of these parts is shown below. In specific designs, the transmission line widths need to be adjusted to the unique dielectric coefficients and thicknesses as well as varying pick and place equipment tolerances.

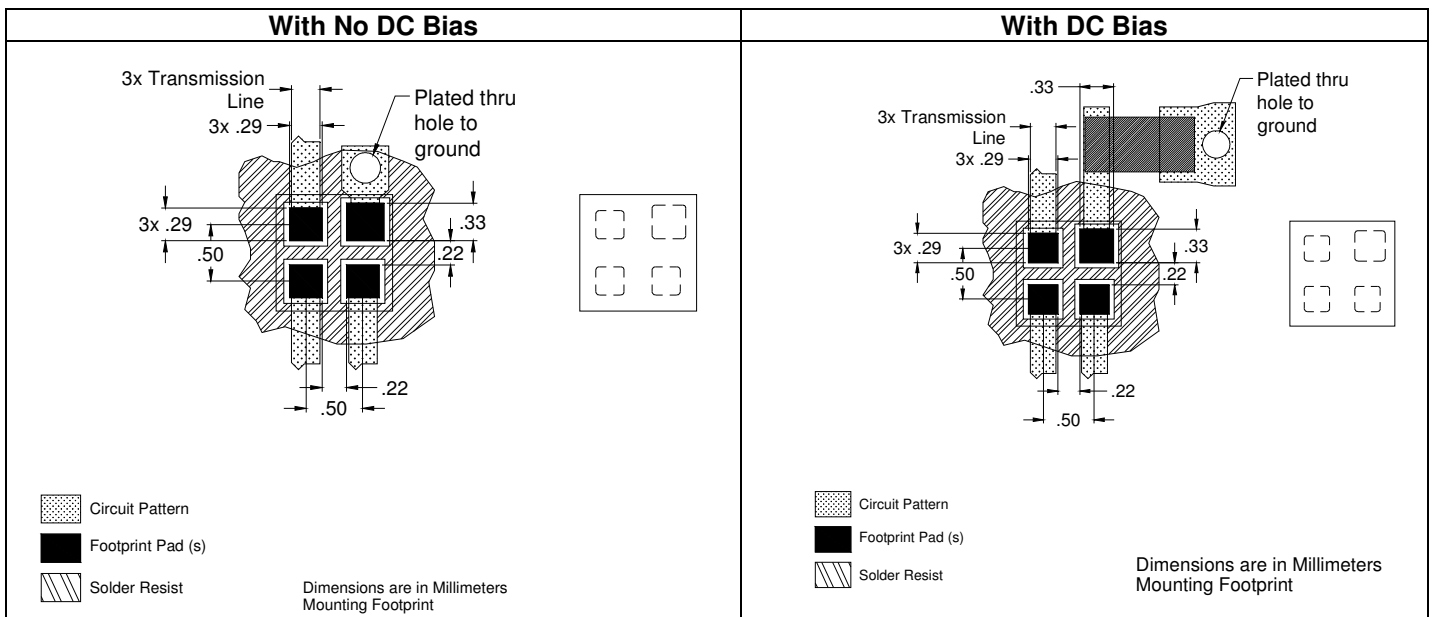

Packaging and Ordering Information

Parts are available in reel and are packaged per EIA 481-D. Parts are oriented in tape and reel as shown below. Minimum order quantities are 4000 per reel.

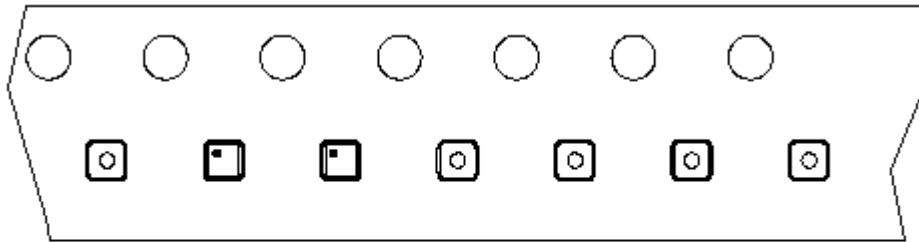

Direction of
Part Feed
(Unloading)

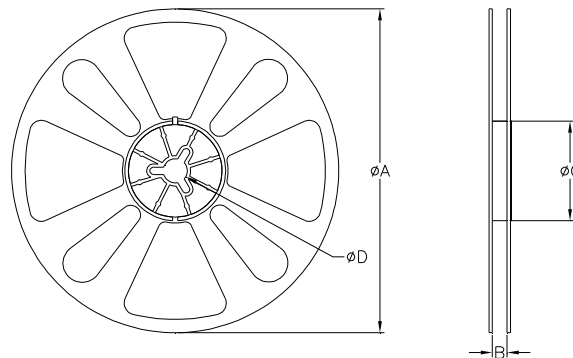

TABLE 1		
QUANTITY/REEL	REEL DIMENSIONS mm	
4000	øA	177.80
	B	8.00
	øC	50.80
	øD	13.00