

MIO-5250 MI/O-Compact SBC, Intel® Atom™ N2600 / D2550, DDR3, HDMI, Dual LVDS, VGA, 2GbE, CFast, iManager, MIOe Startup Manual

Packing List

Before you begin installing your board, please make sure that the following items have been shipped:

- 1 x MIO-5250 SBC
- 1 x SATA Cable 32cm (P/N 1700008941)
- 1 x SATA Power Cable 35cm (P/N 1700018785)
- 1 x Audio Cable 20cm (P/N 1700019584)
- 2 x COM RS-232 Cable 22cm (P/N 1701200220)
- 2 x COM RS-422/485 Cable 25cm (P/N 1700019435)
- 1 x Heatsink (20mm) (P/N: 1960054274T001)
- Startup Manual
- CD-ROM (Manual, Driver, Utility)
- 1 x Mini Jumper(10pcs package) (P/N 9689000002)

If any of these items are missing or damaged, please contact your distributor or sales representative immediately.

Note1: For detailed contents of MIO-5250, please refer to information on the enclosed CD-ROM (in PDF format).

Note1: Acrobat Reader is required to view any PDF file. Acrobat Reader can be downloaded at: www.adobe.com/Products/acrobat/readstep2.html (Acrobat is a trademark of Adobe)

For more information on this and other Advantech products, please visit our website at:

<http://www.advantech.com>

<http://www.advantech.com/eplatform>

For technical support and service, please visit our support website at:

<http://service.advantech.com.tw/support/>

This manual is for the MIO-5250.

Part No. 2006M52501
Printed in China

2nd Edition
June 2012

Specifications

General

- **CPU:** Intel® Atom™
 - N2600 (Dual Core 1.6GHz): MIO-5250N-S6A1E
 - D2550 (Dual Core 1.86GHz): MIO-5250D-S8A1E
- **System Memory:** 1 x 204-pin SODIMM socket DDR3 up to 4GB
 - N2600: DDR3 800MHz
 - D2550: DDR3 1066MHz
- **2nd Cache Memory:**
 - N2600: 1MB
 - D2550: 1MB
- **System Chipsets:** Intel® Atom™ N2600/D2550 + NM10
- **BIOS:** AMI EFI 16-Mbit
- **Watchdog Timer:** 255 levels timer interval, programmable by software. Multi level WDT (set by iManager)
- **Expansion Interface:** Full-size Mini PCIe, CFast, SIM Holder, MIOe
- **Battery:** Lithium 3 V / 210 mAh
- **Audio:** Supports High Definition Audio (HD), line-in, line-out, Mic-in

Display

- **Controller:** Intel® Atom™ N2600 / D2550
- **Resolution:**
 - VGA: N2600 / D2550: 1920 x 1200
 - LVDS:
 - N2600: 24-bit LVDS1, resolution up to 1366 x 768
 - D2550: 24-bit LVDS1, resolution up to 1440 x 900, 48-bit LVDS2, resolution up to 2560 x 1600 (LVDS2 JEIDA support)
 - HDMI:
 - Supports 1920 x 1200p @60Hz, 36bpp
 - Supports HDMI 1.3, Max data rate up to 1.65Gb/s
- **Dual Independent Display:** VGA+LVDS, VGA+HDMI, HDMI+LVDS

Ethernet Interface

- **Speed:** GbE 10/100/1000 Mbps
- **Chipset:** Intel® 82583V (GbE1, GbE2)
- **Ethernet Interface:** Fully compliant with IEEE 802.3, IEEE 802.3u, IEEE 802.3ab
- **Connector:** RJ45 x2

I/O

- **Internal I/O Interface:** 1 x SATAII, 2 x RS-232, 2 x RS232/422/485, 2 x USB 2.0, GPIO, SMBus, HD Audio
- **Rear I/O:** 4 x USB 2.0, HDMI, VGA, 2 x RJ45 Ethernet, DC Power in connector
- **Power connector type:** MIO-5250N-S6A1E: DC Jack
MIO-5250D-S8A1E: 2 x 2 pin power connector
- **GPIO:** 8-bit general purpose input/output

Specifications

Mechanical and Environmental

- **Dimensions (L x W):** 146 x 102 mm (5.7 x 4 inches)
- **Power Supply Type:** APM 1.2, ACPI support
- **Power Requirement:** +12 V \pm 10%
- **Power Consumption:** with 2GB DDR3 1066 SO-DIMM
 - Max in HCT12:
 - MIO-5250N-S6A1E: +12V @ 0.729A
 - MIO-5250D-S8A1E: +12V @ 0.829A
 - Typical: Idle mode in WindowsXP
 - MIO-5250N-S6A1E: +12V @ 0.524A
 - MIO-5250D-S8A1E: +12V @ 1.029A
- **Operating Temperature:** 0–60°C (32–140°F)
- **Weight:** 0.72 kg (reference weight of total package)

Jumpers and Connectors

The board has a number of connectors and jumpers that allow you to configure your system to suit your application.

The table below lists the function of each of the jumpers and connectors.

Jumpers

Label	Function
J1	24-bit LVDS1 Power
J2	48-bit LVDS2 Power
J3	Auto Power on setting
J4	COM2 Setting
J5	COM3 setting
J6	Clear CMOS

Connector

Lable	Function
CN1	12V Power Input
CN2	DC JACK
CN3	DDR3 SO-DIMM
CN5	Power Switch
CN7	Reset
CN9	GPIO
CN10	VGA
CN11	CFast
CN12	SIM Holder
CN13	Full-size Mini PCIe
CN14	SATA
CN15	SATA Power
CN16	USB 3/4
CN17	Internal USB
CN18	USB 1/2

Jumpers and Connectors

CN19	COM1/COM2 RS-232
CN20	RS422/485 1
CN22	RS422/485 2
CN24	COM3/COM4 RS-232
CN25	SMBus
CN26	System FAN
CN28	LAN
CN30	Audio
CN31	MIOe
CN33	24 bits LVDS1 Panel
CN34	LVDS2 Inverter Power
CN35	48 bits LVDS2 Panel
CN36	HDMI
CN38	LVDS1 Inverter Power

J1: 24 bits LVDS1 Power

Part Number	1653003260
Footprint	HD_3x2P_79
Description	PIN HEADER 3x2P 2.0mm 180D(M) SMD 21N22050
Setting	Function
(1-3)*	+3.3V
(3-5)	+5V
(3-4)	+12V

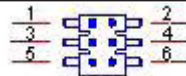

J2: 48 bits LVDS2 Power

Part Number	1653003260
Footprint	HD_3x2P_79
Description	PIN HEADER 3x2P 2.0mm 180D(M) SMD 21N22050
Setting	Function
(1-3)*	+3.3V
(3-5)	+5V
(3-4)	+12V

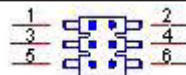

Jumpers and Connectors

J3: Auto Power On Setting

Part Number	1653002101
Footprint	HD_2x1P_79_D
Description	PIN HEADER 2*1P 180D(M)SQUARE 2.0mm DIP W/O Pb
Setting	Function
NC	Power Button for Power On
(1-2)*	Auto Power On



J4: COM2 Setting

Part Number	1653003260
Footprint	HD_3x2P_79
Description	PIN HEADER 3x2P 2.0mm 180D(M) SMD 21N22050
Setting	Function
(1-2)*	RS232
(3-4)	RS485
(5-6)	RS422

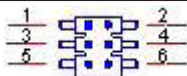

J5: COM3 Setting

Part Number	1653003260
Footprint	HD_3x2P_79
Description	PIN HEADER 3x2P 2.0mm 180D(M) SMD 21N22050
Setting	Function
(1-2)*	RS232
(3-4)	RS485
(5-6)	RS422

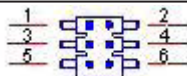

J6: Clear CMOS

Part Number	1653003101
Footprint	HD_3x1P_79_D
Description	PIN HEADER 3x1P 2.0mm 180D(M) DIP 2000-13 WS
Setting	Function
(1-2)*	Normal
(2-3)	Clear CMOS



Connector Locations

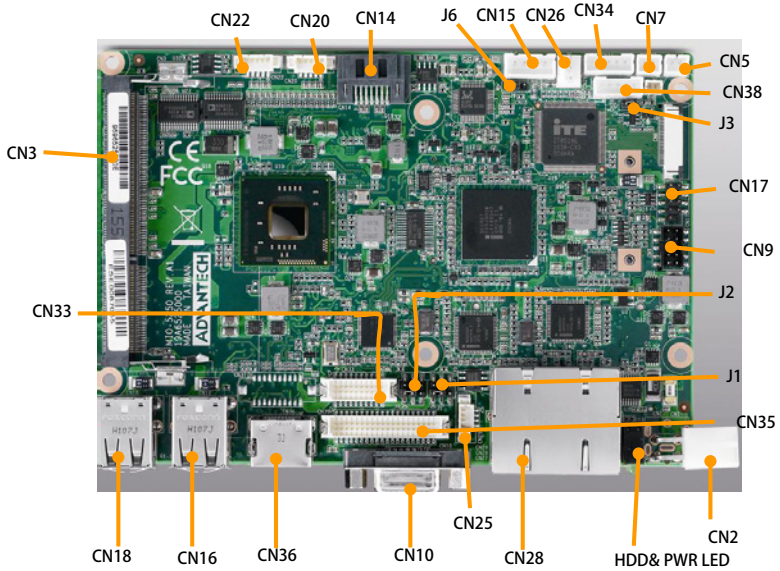

Figure 1: MIO-5250 Connector Locations (Top Side)

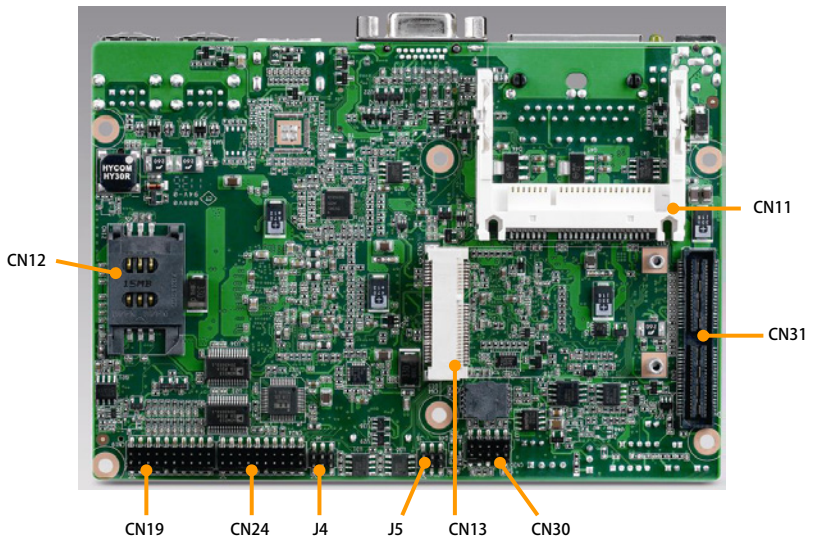

Figure 2: MIO-5250 Connector Locations (Bottom Side)

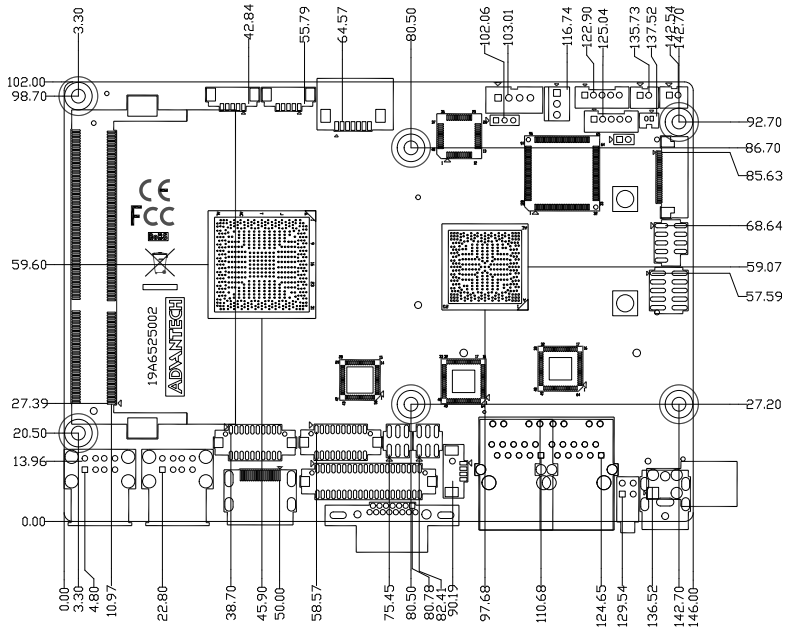

Figure 4: MIO-5250 Mechanical Drawing (Top Side)

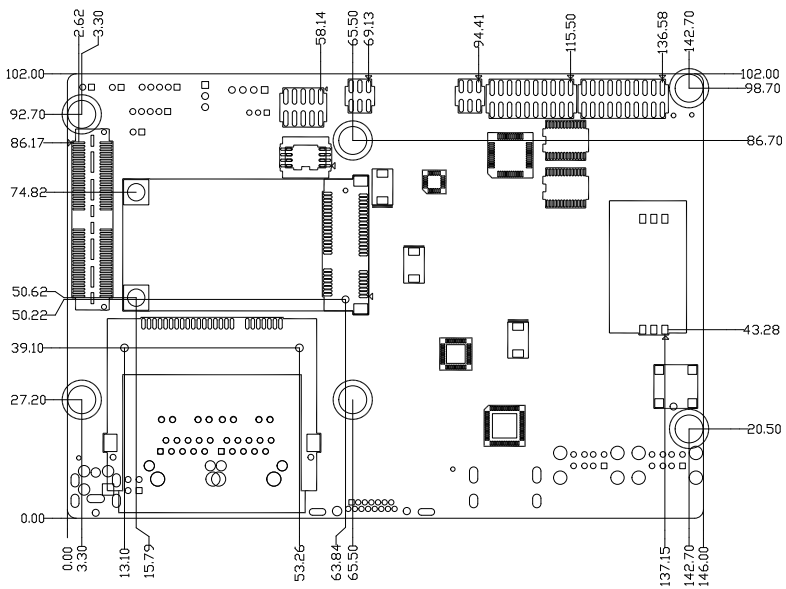

Figure 5: MIO-5250 Mechanical Drawing (Bottom Side)

Dimensions

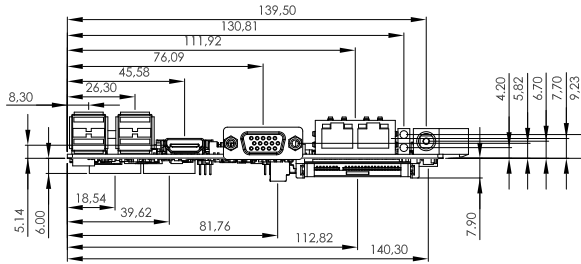
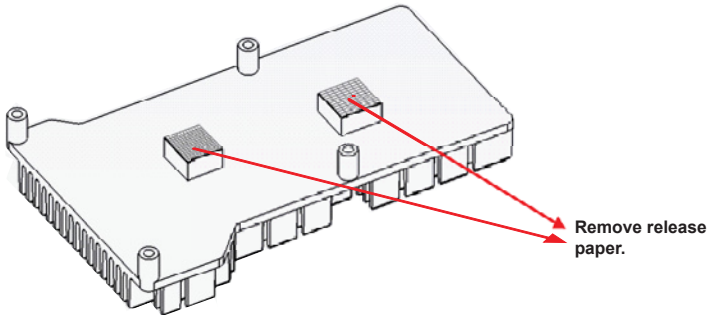

Figure 6: MIO-5250 Mechanical Drawing (Side View)

Quick Installation Guide

1. There is a Heatsink / Cooler in the white box, please take it and remove the release paper from the thermal pads.



2. There are four screws inside the white box, please install DRAM in the SO-DIMM socket, then screw the heatsink into place as per illustration below:

